



INSTRUCTIONS D'ASSEMBLAGE
ASSEMBLY INSTRUCTIONS

MONARCH
SPECIALTIES INC.

I 2494

ETAGERE -
72"H / CERISE EN COIN

BOOKCASE -
72"H / CHERRY CORNER ACCENT ETAGERE



POUR DE L'ASSISTANCE OU POUR COMMANDER
DES PIÈCES CONTACTEZ NOTRE DÉPARTEMENT
DE SERVICE À LA CLIENTÈLE.

FOR ASSISTANCE OR TO ORDER PARTS
CONTACT OUR CUSTOMER SERVICE DEPARTMENT

WWW.MONARCHSERVICE.COM

LISTE DES PIÈCES
PARTS LIST

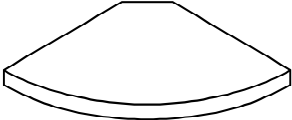
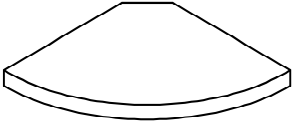
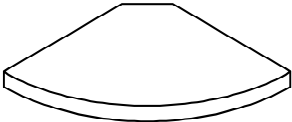
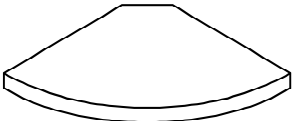
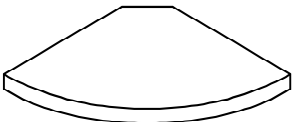
PIÈCE / PART #	IMAGE	DESCRIPTION	QTY / QTÉ
1		TOP SHELF ÉTAGÈRE SUPÉRIEURE	1
2		SHELF PANEL PANNEAU DE TABLETTE	1
3		SHELF PANEL PANNEAU DE TABLETTE	1
4		SHELF PANEL PANNEAU DE TABLETTE	1
5		SHELF PANEL PANNEAU DE TABLETTE	1

LISTE DES PIÈCES
PARTS LIST

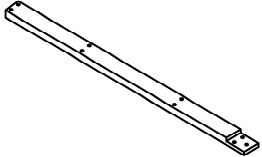
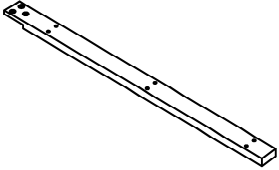
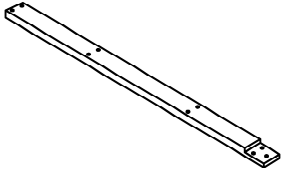
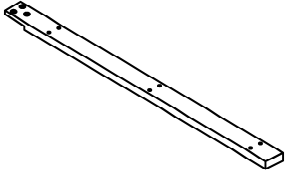
PIÈCE / PART #	IMAGE	DESCRIPTION	QTY / QTÉ
6		<p>BOTTOM SHELF ÉTAGÈRE DU BAS</p>	1
7		<p>FRONT FACING LEFT LEG PATTE AVANT GAUCHE</p>	1
8		<p>FRONT FACING LEFT LEG PATTE AVANT GAUCHE</p>	1
9		<p>FRONT FACING RIGHT LEG PATTE AVANT DROITE</p>	1
10		<p>FRONT FACING RIGHT LEG PATTE AVANT DROITE</p>	1

LISTE DES PIÈCES
PARTS LIST

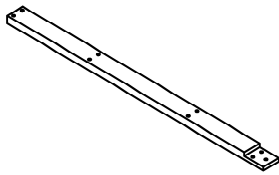
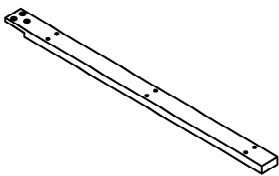
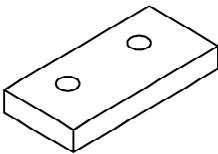
PIÈCE / PART #	IMAGE	DESCRIPTION	QTY / QTÉ
11		<p>BACK LEG SUPPORT BARRE DE SOUTIEN ARRIERE</p>	1
12		<p>BACK LEG SUPPORT BARRE DE SOUTIEN ARRIERE</p>	1
13		<p>SUPPORT LEG PATTE DE SOUTIEN</p>	1

LISTE DES PIÈCES DE MONTAGE
HARDWARE LIST

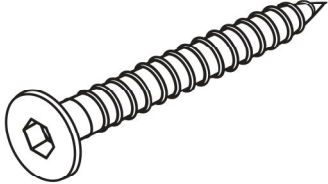
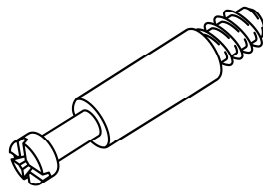
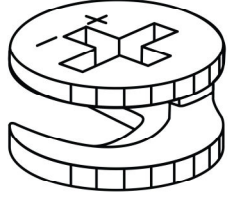
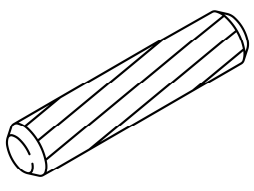
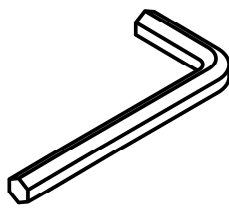
PIÈCE / PART #	IMAGE	DESCRIPTION	QTY / QTÉ
A		ASSEMBLING SCREW - Ø1/4" X 2" VIS D'ASSEMBLAGE - Ø1/4" X 2"	18
B		CAM LOCK SCREW VIS CAM LOCK	2
C		CAM LOCK CONNECTOR ÉCROU CAM LOCK	2
D		WOOD DOWEL GOUJON DE BOIS	18
E		HEX KEY CLÉ HEXAGONALE	2

LISTE DES PIÈCES DE MONTAGE
HARDWARE LIST

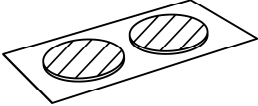
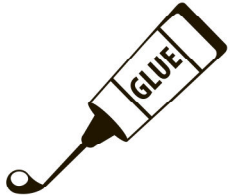
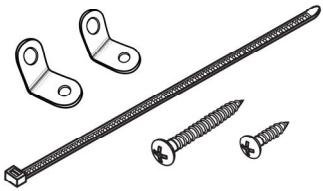
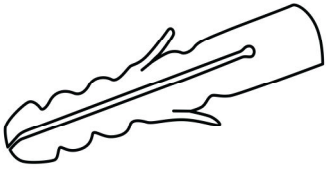
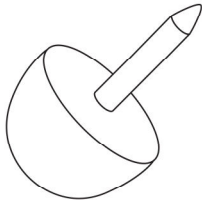
PIÈCE / PART #	IMAGE	DESCRIPTION	QTY / QTÉ
F		FINISHING STICKER COLLANT DE FINITION	36
G		GLUE COLLE	1
H		WALL MOUNT SET ENSEMBLE DE MONTAGE MURAL	1
I		ANCHOR ANCRE	1
J		FLOOR PROTECTOR PROTECTEUR DE PLANCHER	5

LISTE DES PIÈCES DE MONTAGE
HARDWARE LIST

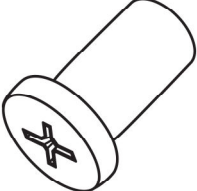
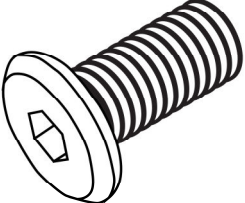
PIÈCE / PART #	IMAGE	DESCRIPTION	QTY / QTÉ
K		BARREL NUT ÉCROU DE CANON	9
L		ASSEMBLING BOLT - Ø1/4" X 1/2" BOULON D'ASSEMBLAGE - Ø1/4" X 1/2"	9



OUTIL DE VÉRIFICATION DE DIMENSIONS DES PIÈCES
HARDWARE DIMENSIONS VERIFICATION TOOL



ÉTAPE / STEP 1

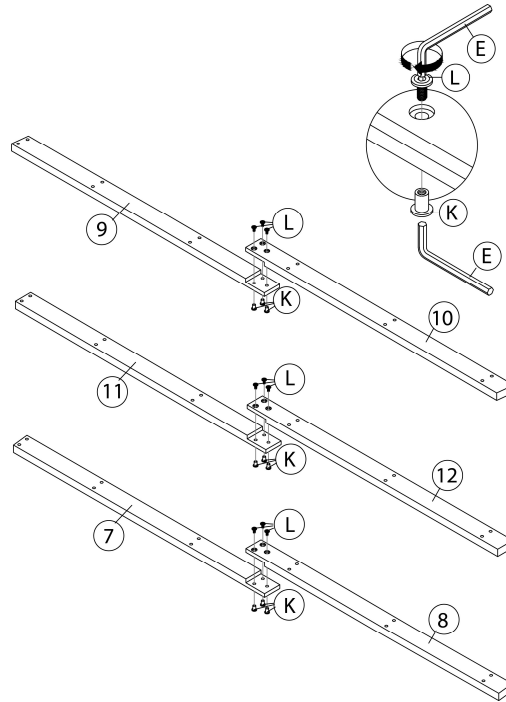

ÉTAPE / STEP 2

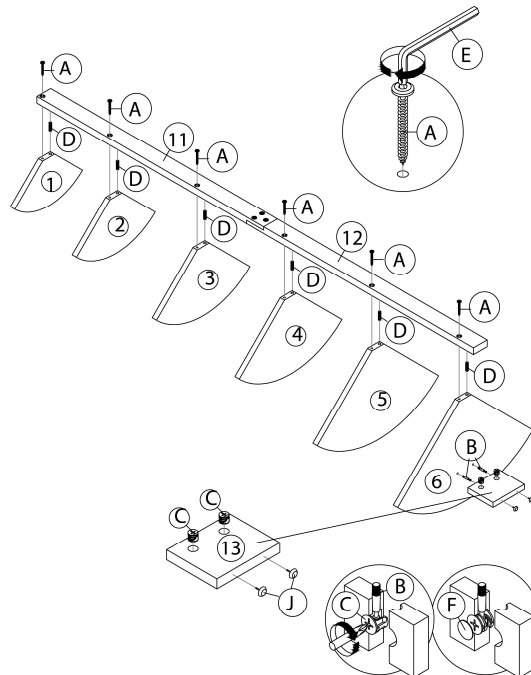

ÉTAPE / STEP 3

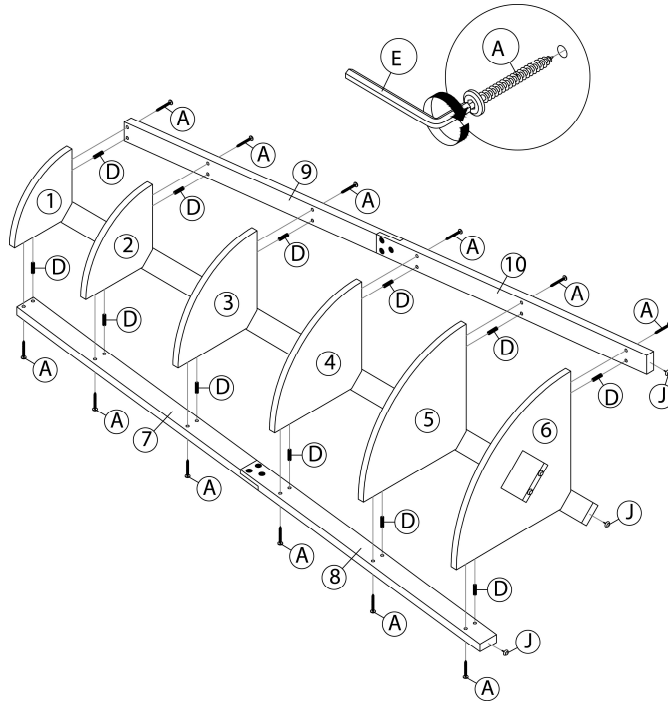

ÉTAPE / STEP 4

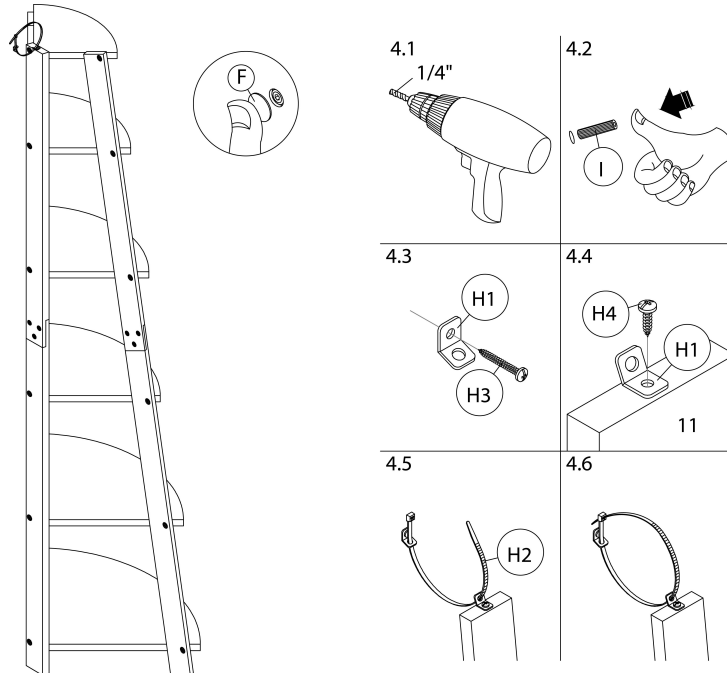

ÉTAPE / STEP 5

